

COOLING

EVAPORATIVE COOLING MEDIA AND COOLING SYSTEMS



since
1967



Evaporative panels **PERICOOL®** are a simple and economical way to humidify the air in big spaces with minimum energetic costs thanks to the adiabatic process.

A water distribution system pours the water into the evaporative panel in order to impregnate uniformly its special honeycomb structure. At this point the air passing through the panel partially transfers its heat to the water, causing its evaporation.



The distributor panel guarantees a uniform pads wetting and higher performances



Honeycomb structure specifically developed to achieve high performances



A wide range of geometries is available for different applications



The panel is treated with special odourless resins, which guarantee a highly rigid structure and optimal water absorption capacity



AAT Anti-vegetative surface treatment which also improves the pads structural resistance (optional)



7



5

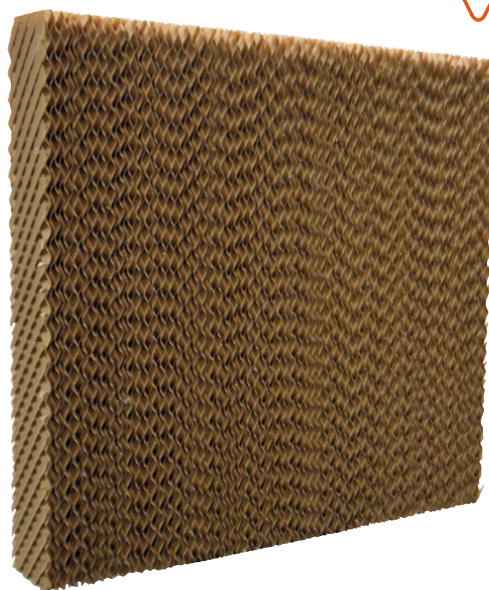

Technical features

PERICOOL[®]

TYPE 4545/7

Suitable for application conditions where a good balance between humidification efficiency and pressure drop is required.

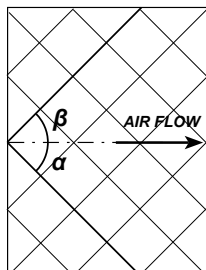

$\alpha = 45$ $\beta = 45$

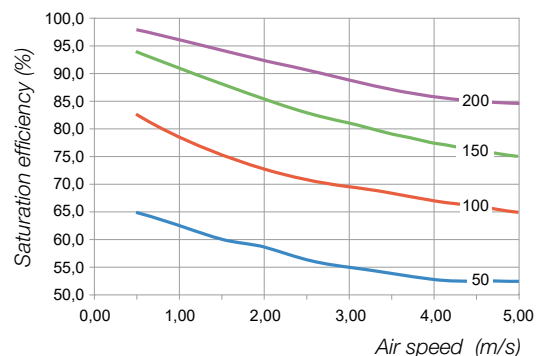
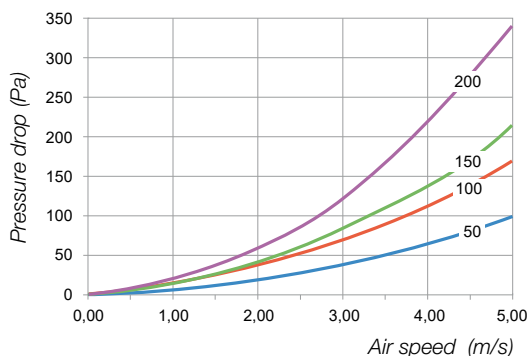

TYPE 1545/7

Particularly suitable where low pressure drop as well as reasonable humidification efficiency are required.

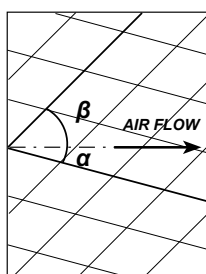

$\alpha = 15$ $\beta = 45$

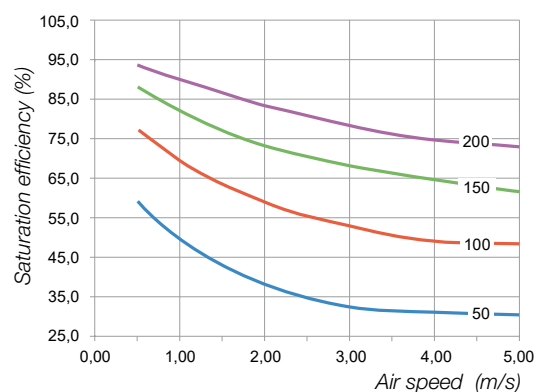
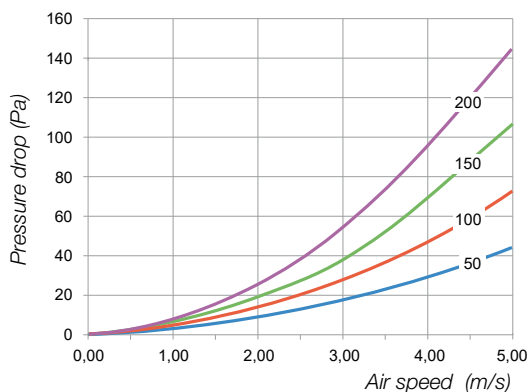

TYPE 3060/7 (version available on request - MOQ required)

Suitable for application conditions where a good balance between humidification efficiency and pressure drop is required.

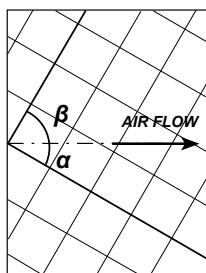

$\alpha = 30$ $\beta = 60$

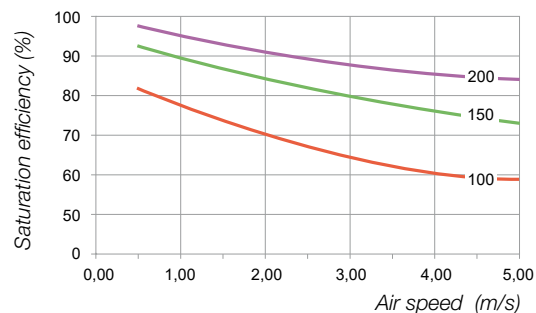
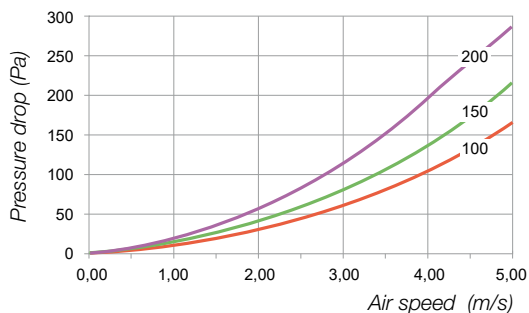

TYPE 4545/5

Suitable for application conditions where a good balance between humidification efficiency and pressure drop is required.

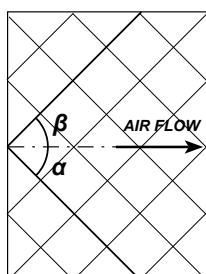

$\alpha = 45$ $\beta = 45$

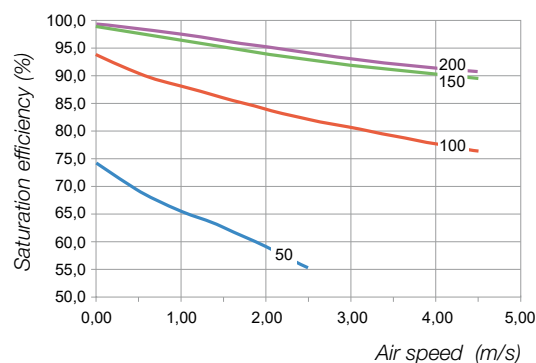
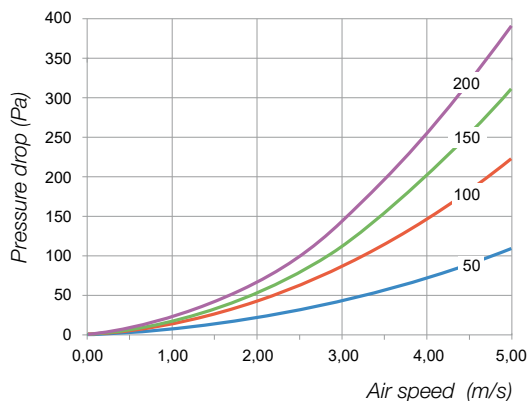

Note: risk of drops ejection in case of air speed through the pads > 3 m/s.

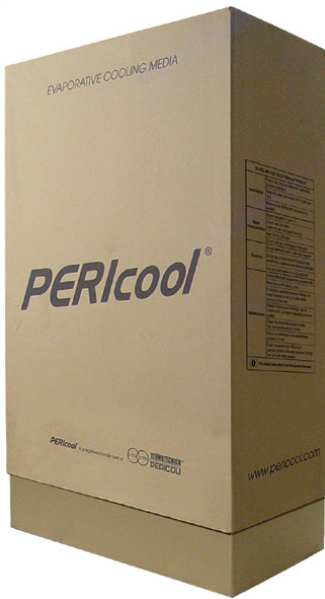

Installation

- Follow the product installation manual for correct installation
- Keep the water tank away from direct sun light
- Minimize the exposure of the evaporative panels to sunlight

Water characteristics

- Be sure to have $6 < \text{pH} < 8$
- Do not use hot water (water at room temperature only)
- Max CaCO_3 250 ppm
- Do not add any chemicals to the water

Cleaning

- Do not wash with water under high pressure
- Do not use products that contain chlorine, weed killers or any other chemical products
- Use only clean water and a dry soft brush

Maintenance

- Dry completely once every 24 hours
- Minimize frequent wetting and drying cycles
- During the operating season change the water weekly by removing the entire contents of the tank
- Maintain the mineral discharge ratio at minimum 5% (or higher depending on water quality)
- Clean the water filters once a week (do not operate without filters)
- Avoid contamination with weed killers, dust or any other chemical products
- In case of long non-operating period remove the water completely from the evaporative panel and the tank

Dimensions and loading possibilities

Dimensions	7	5
Length - L - [mm]	600	600
Height - H - [mm]	1000, 1200, 1500, 1800, 2000	1000, 1500, 1800, 2000
Thickness - T - [mm]	50, 100, 150, 200	50, 100, 150, 200
Angle with respect to airflow direction - α	45, 15	45
Angle with respect to water direction - β	45	45
Distribution panel height - Hd - [mm]	30	30
Wave height - Hp - [mm]	7	5

Note: other measures, thicknesses and angles are upon request.

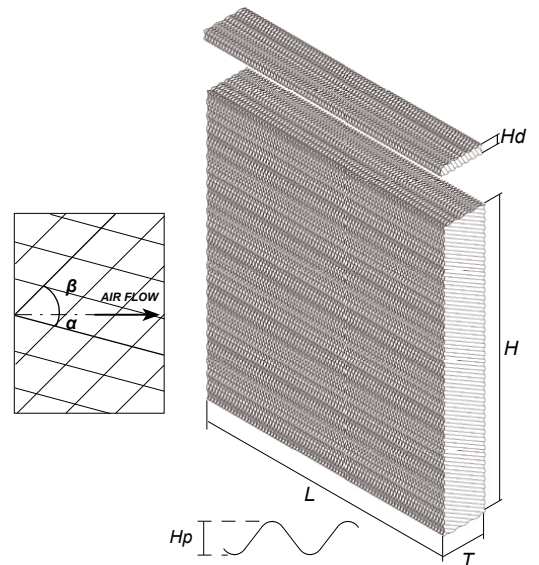

Dimensions of evaporative panel boxes

Model	1000x600x				1200x600x				1500x600x				1800x600x				2000x600x			
	50	100	150	200	50	100	150	200	50	100	150	200	50	100	150	200	50	100	150	200
Measurements	1020x620x1120				1220x620x1120				1520x620x1120				1820x620x1120				2020x620x1120			
Nr of panels	22	11	7	5	22	11	7	5	22	11	7	5	22	11	7	5	22	11	7	5

Loading possibilities of evaporation cooling media with distribution panel (without pallet)

Model	1000x600x				1200x600x				1500x600x				1800x600x				2000x600x			
	50	100	150	200	50	100	150	200	50	100	150	200	50	100	150	200	50*	100	150	200
Container 20ft	858	429	273	195	682	341	217	155	572	286	182	130	462	231	147	105	396	198	126	90
Container 40ft	1782	891	567	405	1452	726	462	330	1188	594	378	270	968	484	308	220	902	451	287	205
Container 40ft HC	2156	1045	672	480	1672	803	518	370	1408	693	441	315	1100	550	350	250	1078	528	336	240

METAL FRAME SYSTEM WITH TANK-GUTTER

MDFX

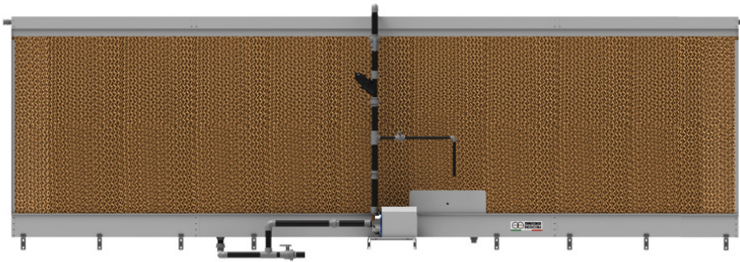

This product is made up by stainless steel gutter frames, without any additional external water storage thanks to a special lower gutter, which serves as a tank. This innovative system is easy to install, permits to avoid all costs related to external tank with additional pipes. The lower gutter, although with the same design of the traditional one, has become deeper in order to contain the correct amount of water required by the system to operate. **MDFX** is appreciated not only by customers, but also by installers, maintenance workers and end-users for the simplicity and flexibility that distinguish it.



Deeper gutter frame in AISI 304 stainless steel. 100% recyclable material



Male/female gutters for an easier assembly procedure

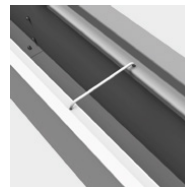

The lower gutter is supported by reinforcements to guarantee rigidity and robustness

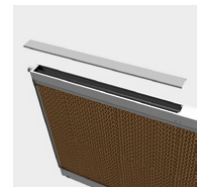

No tools needed for inspection and hydraulic maintenance



F - Filter for water impurity

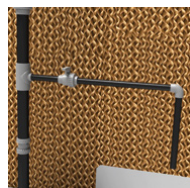

BL - Mineral discharge valve



Water feeding with practical nipple M/F and level float



NWP - Kit flowmeter (optional)



GIK - Inspection kit for water supply and drainage



P7 Lateral profile in 2 parts to cover the height range from 0.5 to 2m



P8 Pipe support makes the assembly procedure easier



P9 Upper seal in a single piece for a higher system's resistance



CLASSIC GUTTER FRAME SYSTEM

The frame system for evaporative cooling pads is made of pre-coated galvanised steel "Pluvimag", and is suitable for installation in a harsh corrosive environment. Simplicity and flexibility are this product's most distinguishing features, and they are highly appreciated by our customers. **MFP** is designed for cooling appliance in the most various fields of application.

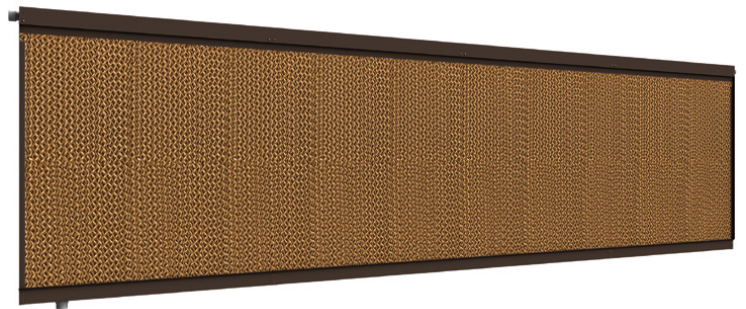

The lower frame profile was specifically shaped to permit to drain the water completely

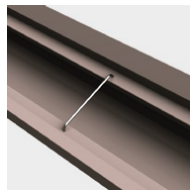

The lower gutter is supported by reinforcements to guarantee rigidity and robustness



The upper frame can be easily removed for cleaning and maintenance



Inside the upper gutter, a drilled pipe wets the distributing pad for a uniform pad's humidification



Male/female gutters for an easier assembly procedure



P7 Lateral profile in 2 parts to cover the height range from 0.5 to 2m



P8 Pipe support makes the assembly procedure easier



P9 Upper seal in a single piece for a higher system's resistance



Water distribution systems

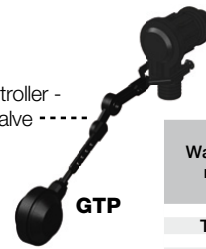
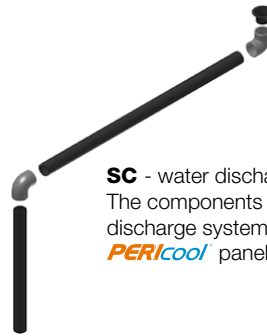
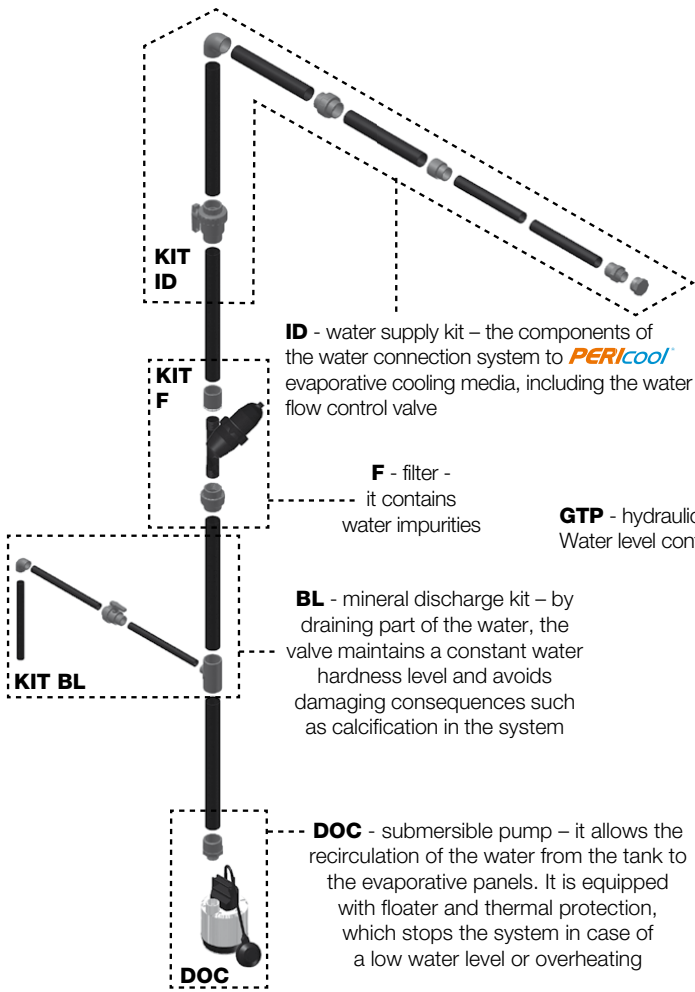

TK - water tank - collects the excess water



Water tank model	Dimensions		
	Capacity (liters)	External diameter (mm)	Height with cover (mm)
TK 500	500	910	985
TK 1000	1000	1110	1390

Pump model	Voltage	Power		Q = capacity										
		kW	HP	l/min	0	25	50	75	100	125	150	175	225	
DOC3	230V 1~	0.25	0.33	6.9	6.3	5.6	4.7	3.7	2.5	1.2	---	---	---	---
DOC7	230V 1~	0.55	0.75	11.1	10.8	10.4	9.9	9.3	8.5	7.6	6.5	3.7	---	---
DOC7T	400V 3~	0.55	0.75	7.2	6.8	6.4	6.0	5.5	4.8	4.1	3.1	---	---	

H = total head in meters water column

MDFX MFP

Dimensions

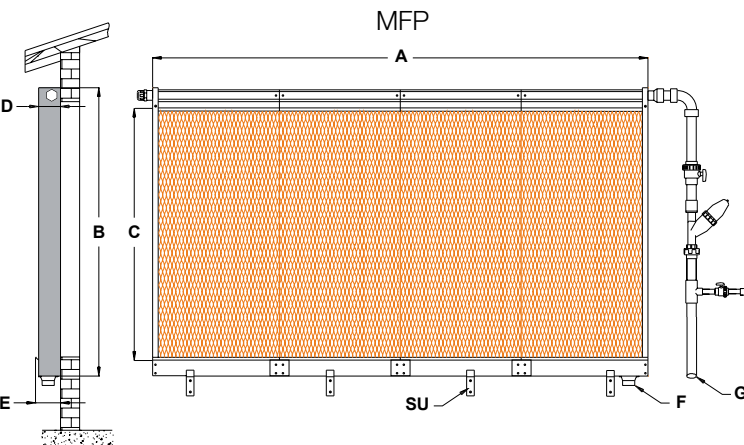
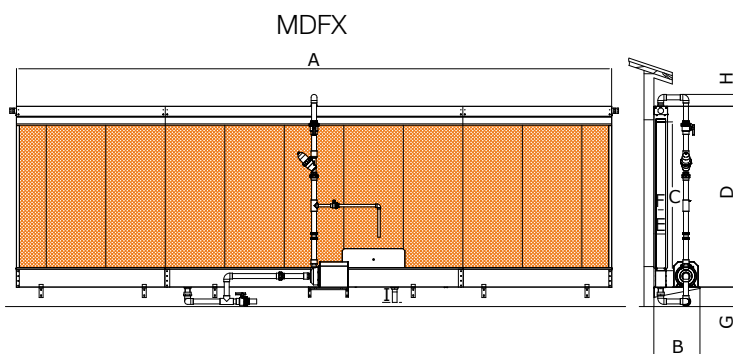

Dimensions							
	MDFX 100			MDFX 150			
	MDFX 10	MDFX 20	MDFX 30	MDFX 10	MDFX 20	MDFX 30	
A	3m - 12m	12.6m - 18m	18m - 39m	3m - 12m	12.6m - 18m	18m - 30m	m
B	465			465			mm
C	500/1000/1500/1800/2000			500/1000/1500/1800/2000			mm
D	C + 325			C + 360			mm
E	140			190			mm
F	100			150			mm
G	min 200			min 200			mm
H	min 120			min 120			mm
I	1"F/1,5"M			1"F/1,5"M			inch

Dimensions			
Modules	MFP 10	MFP 20	MFP 30
Length - A - [m]	3m - 12m	12.6m - 18m	18.6m - 30m
Total height - B - [mm]	1160 / 1660 / 1960 / 2160		
Evaporative panel height - C - [mm]	1000 / 1500 / 1800 / 2000		
Evaporative panel thickness - D - [mm]	100 / 150		
Total thickness - E - [mm]	135 / 185		
Ø water discharge pipe - F - [mm]	63		
Ø water supply pipe - G - [mm]	50		
Brackets - SU -	To equip the end parts with, one per meter		

PERICOOLER

EVAPORATIVE COOLER

The evaporative cooler **PERICOOLER** is a very versatile machine, which can efficiently and economically cool down a big quantity of air. It is possible to use the product such in a fixed as well as in mobile configuration for temporary application. The sturdy frame of PERICOOLER is made of steel with zinc/aluminum/magnesium coating for the maximum corrosion resistance. The cooling pads can be easily removed to ensure an easy maintenance and cleaning of the machine. The water tank has a great capacity (335 litres) in order to guarantee long continuous operation hours. Available also in unassembled version (KD).



SK kit (optional) safety net for propeller, round air diffuser outlet preset for installation of polyethylene duct

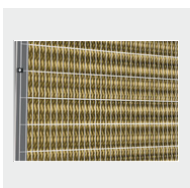

Kit **NT3** (optional) installation of safety nets possible for all three panels



CXF-PC 31 - Electrical panel (optional)

- Safety motor magnetothermic switch
- Built-in socket with phase inverter
- Manual switch for water tank emptying
- Machine can be controlled by thermostat or by humidistat



Kit **WSK** (optional)
Wheels for mobile installation

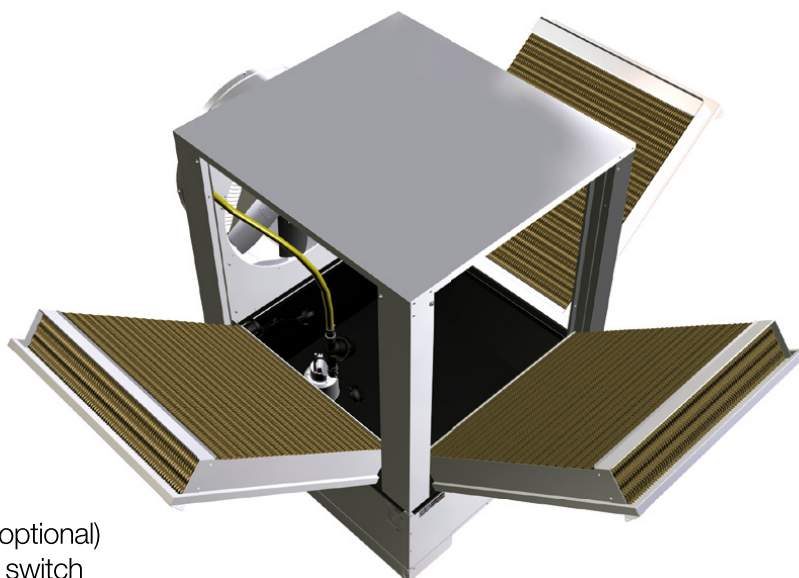

TAP (option) cover for evaporative pads



Technical features

PERICOOLER



		Outside relative humidity (%)									
		15	20	25	30	35	40	45	50	55	
Outside temperature °C	30	Temperature C/Humidity % at machine outlet / water consumption / operating time									
		16.8°C 77.4% 2.3 l/min 1h 50'	17.8°C 79.6% 2.1 l/min 2h	18.8°C 81.7% 2 l/min 2h 5'	19.7°C 83.6% 1.8 l/min 2h 20'	20.7°C 85.3% 1.7 l/min 2h 30'	21.5°C 86.9% 1.5 l/min 2h 45'	22.4°C 88.4% 1.4 l/min 2h 55'	23.2°C 89.8% 1.2 l/min 3h 25'	24°C 91.1% 1.1 l/min 3h 50'	
	35	20°C 76.6% 2.6 l/min 1h 35'	21.2°C 79% 2.4 l/min 1h 45'	22.3°C 82.1% 2.2 l/min 1h 55'	23.5°C 83.3% 2 l/min 2h 5'	24.6°C 85.1% 1.9 l/min 2h 10'	25.6°C 86.8% 1.7 l/min 2h 30'	26.5°C 88.3% 1.5 l/min 2h 45'	27.4°C 89.7% 1.4 l/min 2h 55'	28.3°C 91.1% 1.2 l/min 3h 25'	
		40	23.2°C 75.9% 2.9 l/min 1h 25'	24.7°C 78.5% 2.7 l/min 1h 30'	26°C 80.9% 2.5 l/min 1h 40'	27.3°C 83% 2.3 l/min 1h 50'	28.5°C 84.9% 2.1 l/min 2h	29.6°C 86.5% 1.9 l/min 2h 10'	30.7°C 88.2% 1.7 l/min 2h 30'	31.7°C 89.6% 1.5 l/min 2h 45'	32.7°C 91% 1.3 l/min 3h 10'
	45		26.5°C 75.7% 3.3 l/min 1h 15'	28.1°C 78.1% 3 l/min 1h 20'	29.7°C 80.5% 2.7 l/min 1h 30'	31.1°C 82.7% 2.5 l/min 1h 40'	32.4°C 84.7% 2.3 l/min 1h 50'	33.7°C 86.5% 2 l/min 2h 5'	34.9°C 88.1% 1.8 l/min 2h 20'	36°C 89.6% 1.6 l/min 2h 35'	37.1°C 91% 1.4 l/min 2h 55'
		50	29.7°C 74.7% 3.6 l/min 1h 10'	31.6°C 77.7% 3.3 l/min 1h 15'	33.3°C 80.3% 3 l/min 1h 20'	34.9°C 82.5% 2.7 l/min 1h 30'	36.4°C 84.6% 2.5 l/min 1h 40'	37.8°C 86.4% 2.2 l/min 1h 55'	39.2°C 88% 2 l/min 2h 5'	40.4°C 89.5% 1.8 l/min 2h 20'	41.6°C 90.9% 1.6 l/min 2h 35'

Data related to PERICOOLER at full operation.

Dimensions and loading possibilities

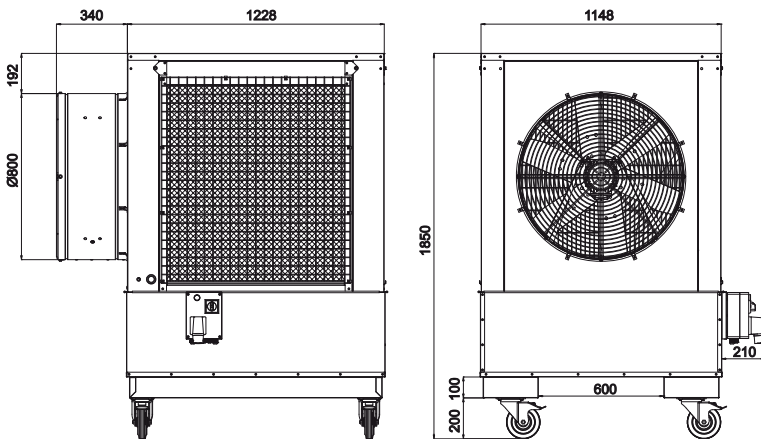

Technical features

Net weight	170 kg	
Weight at full load	505 kg	
Water tank capacity	335 l	
Fan air displacement	18.000 m³/h	
Propeller diameter	768 mm	
Fan electric power	0,55 kW	
Pump electric power	0,3 kW	
Voltage*	Δ 220-240 V	Δ 220-270 V
Frequency	Y 380-420 V 50 Hz	Y 380-460 V 60 Hz
Sound pressure level Lpa** [dB]	64,8 db (A)	

* Single-phase motors available upon request; all three-phase motors can be controlled by inverter.

** Measurement surface according to UNI EN ISO 3744, pic C.7.

Loading possibilities

	Fully assembled version (FA)*	Knock-down version (KD)
Container 20ft	8	20
Container 40ft	16	40
Container 40ft HC	---	50

*To optimize loading possibilities some parts can be supplied unassembled

RWA is a water atomizer with rotating disc to be installed on a circulating fan. It is produced in plastic in order to optimize weight and corrosion resistance. Each model can work with water at standard pressure without any nozzles in order to avoid any possible problem caused by calcification and water impurities. The water flow can be regulated according to the customer's needs.

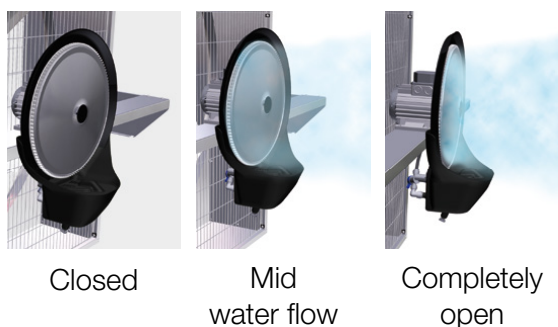

RWA Turbo is a water atomizer with rotating disc and built-in propeller



RWA Turbo O is a professional humidifier with integrated propeller and humidified air outlet diffuser



ACCESSORIES



SVG - fixing bar on square fans EOR-ERD-BKF



SVX - fixing bar in stainless steel on square fans series EOR/ERD Aeternum

SAF - RWA fixing bar on circulation fans series ACF



NT safety net



Technical features, dimensions and loading possibilities

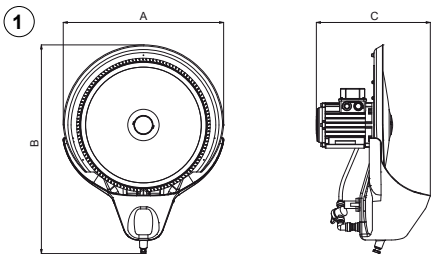

		Dimensions						
	Model	A	B	C	D Ø	E Ø	F	G Ø
1	RWA	432	562	307	---	---	---	---
2	RWA Turbo	518	593	485	478	270	---	---
3	RWA Turbo O	400	507	420	88	196	409	---

Note: measures are given in millimeters

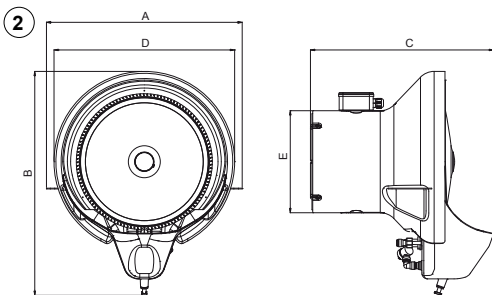

		Technical features					
	Model	Atomizing capacity	Power supply	Protection grade	Weight	Air flow	Absorbed power
		lt/h		IP	kg	m ₃ /h	W
	RWA	15 - 40	1 Ph / 3 Ph + N	56	7,5	---	120
	RWA Turbo 25	15 - 40	1 Ph	55	13	1800	420
	RWA Turbo O 7,5	≤ 7,5	1 Ph	55	13	280	380

Note: 60 Hz version available upon request

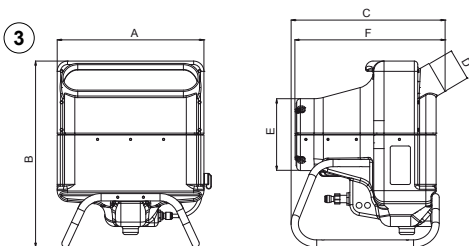

Loading possibilities		
Model	Box	Pallet
RWA	510x610x360mm - 1pc - 10kg	1200x1000x2000 - 20pcs - 220kg
RWA Turbo - RWA Turbo O	460x530x620mm - 1pc - 13kg	1200x800x2000 - 6pcs - 100kg

All data in this catalogue are indicative and are subject to change without prior notice.

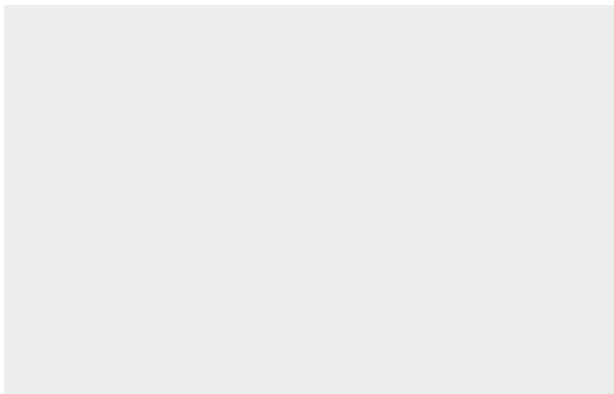

TERMOTECNICA PERICOLI S.r.l.
Regione Rapalline, 44 - 17031 Albenga, Italia
tel. 0182 589006 fax 0182 589005 pit@pericoli.com

PERICOLI ASIA PACIFIC Sdn. Bhd.
pap@pericoli.com

PERICOLI CENTRO AMERICA
pca@pericoli.com

PERICOLI MIDDLE EAST
pme@pericoli.com

PERICOLI INDIA Pvt. Ltd.
pin@pericoli.com

pericoli.com



PERICOOL are registered trademarks by Termotecnica Pericoli S.r.l.